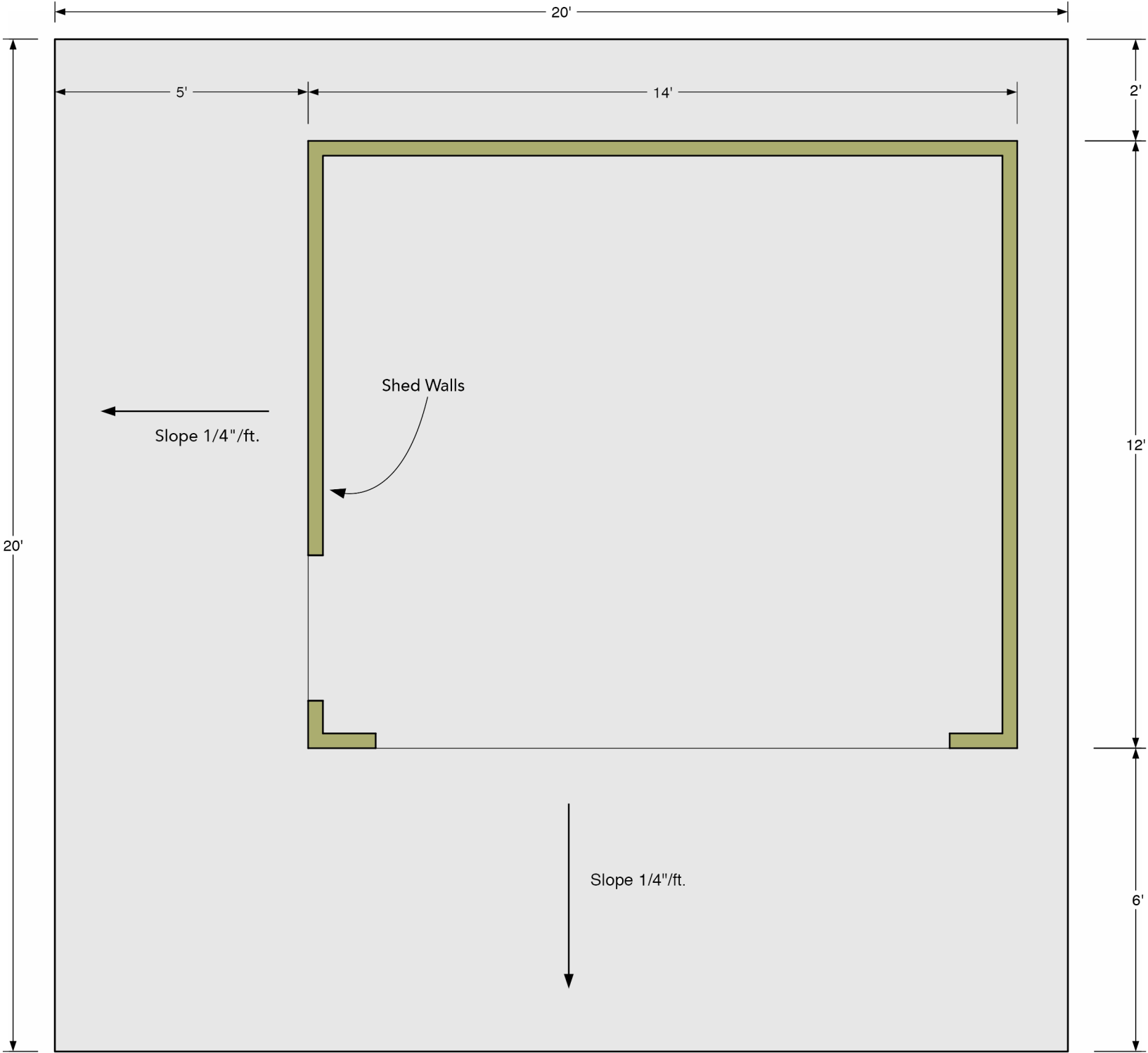
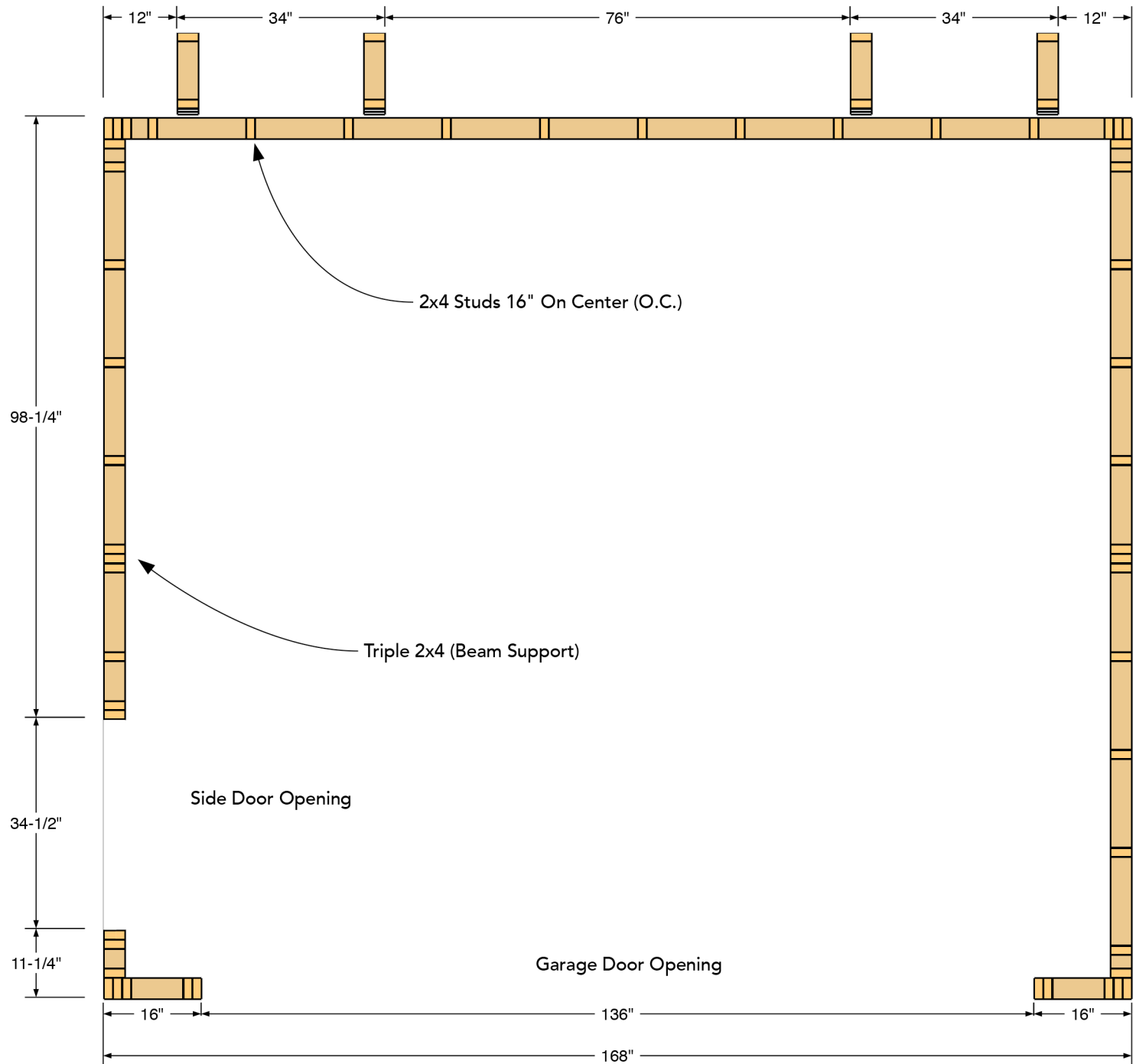

**Figure B**  
**Concrete Pad**



**Figure C**  
**Floor Plan and Stud Placement**



**Figure D**  
**Front and Back Wall Framing**

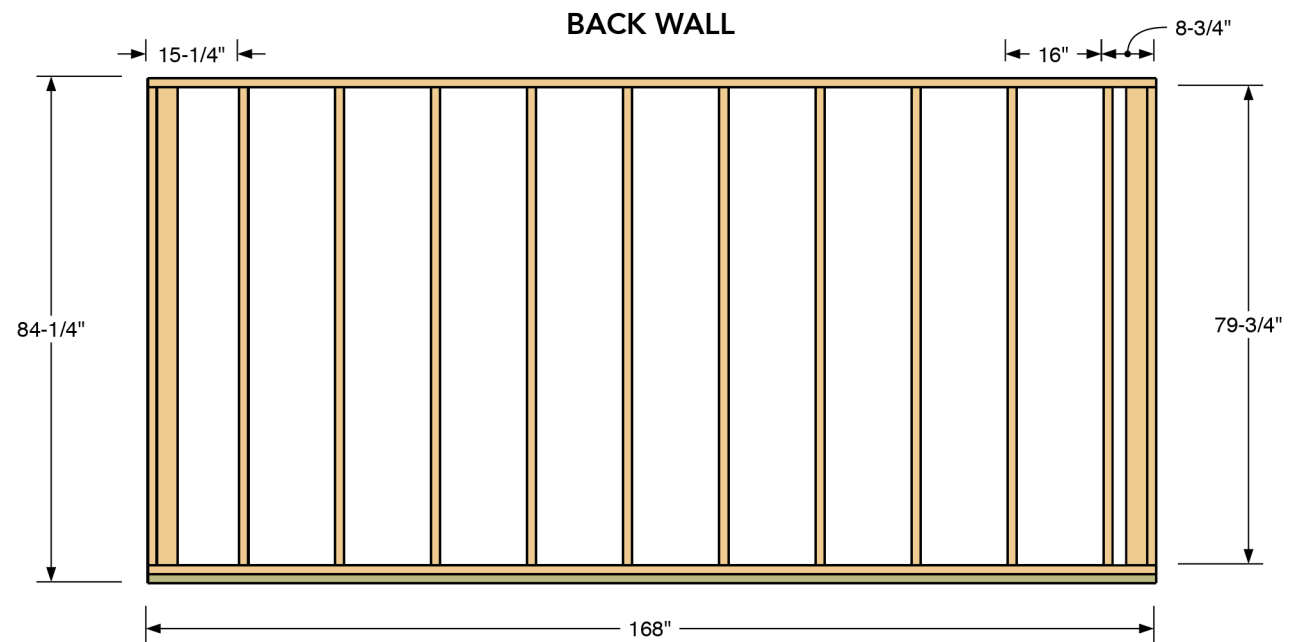
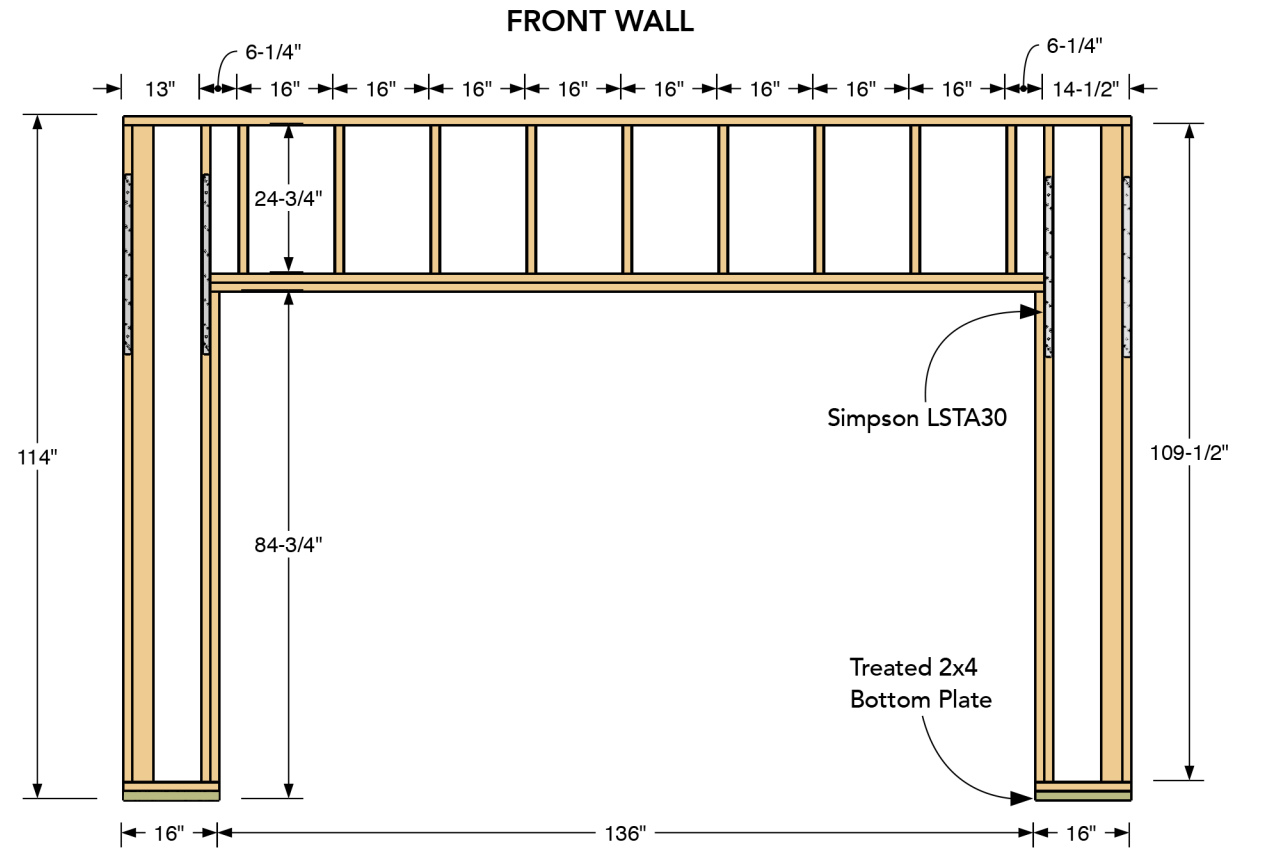

**Figure E**  
**Side Wall Framing**

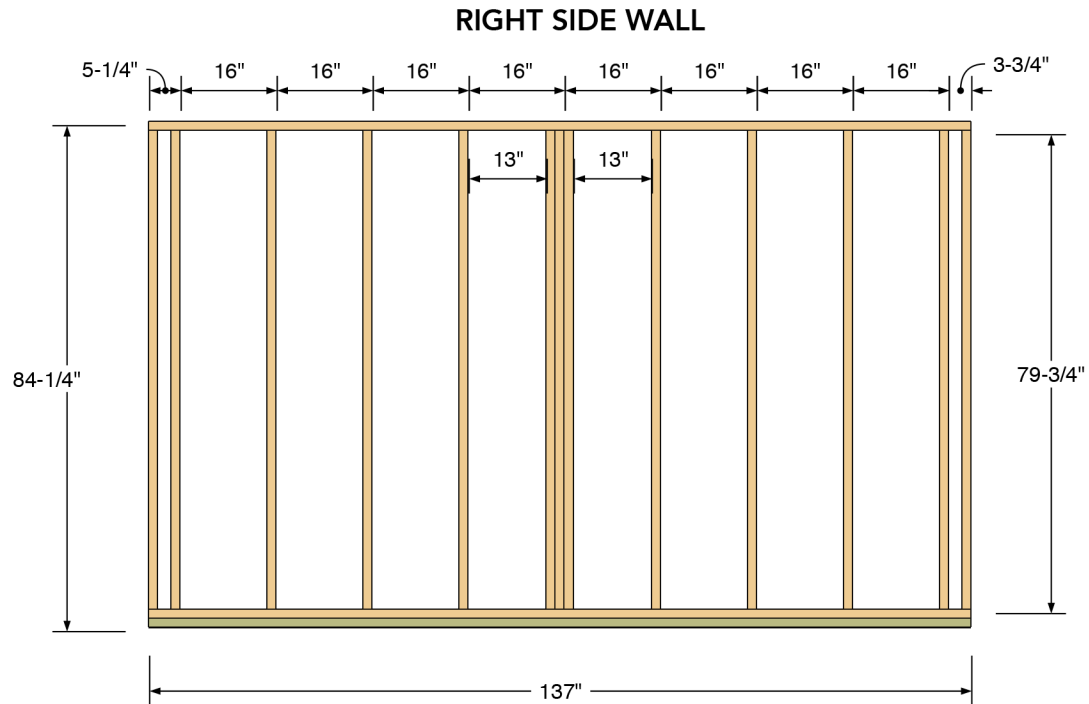
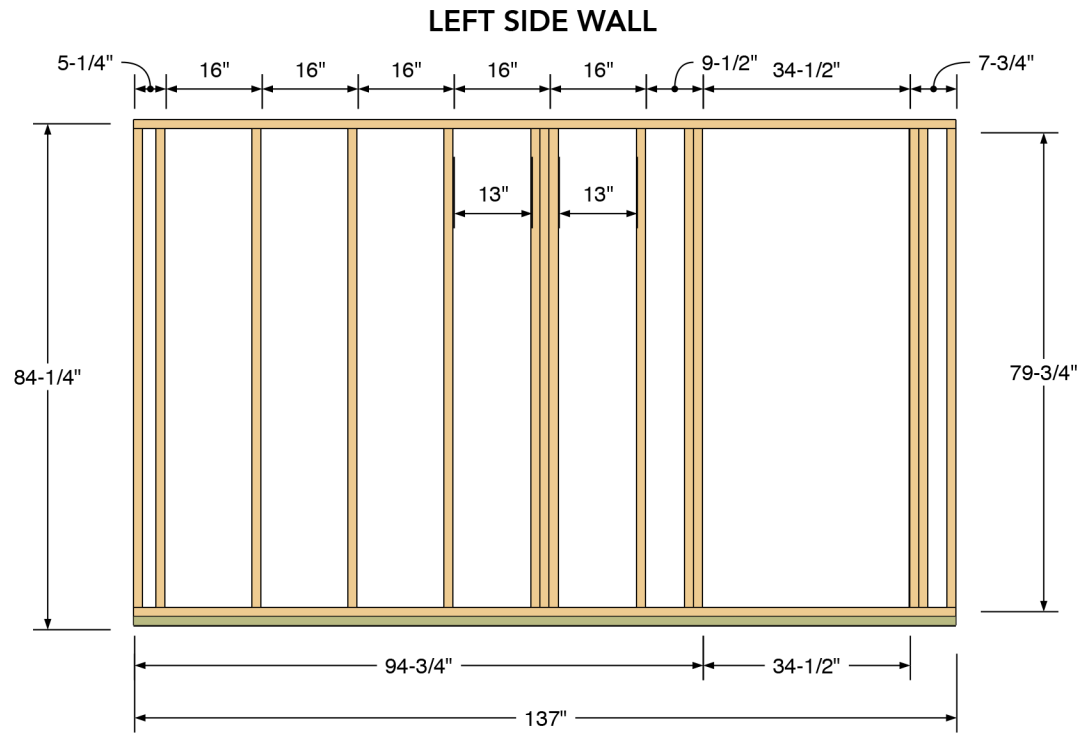

**Figure F**  
**Beams and Upper Side Walls**

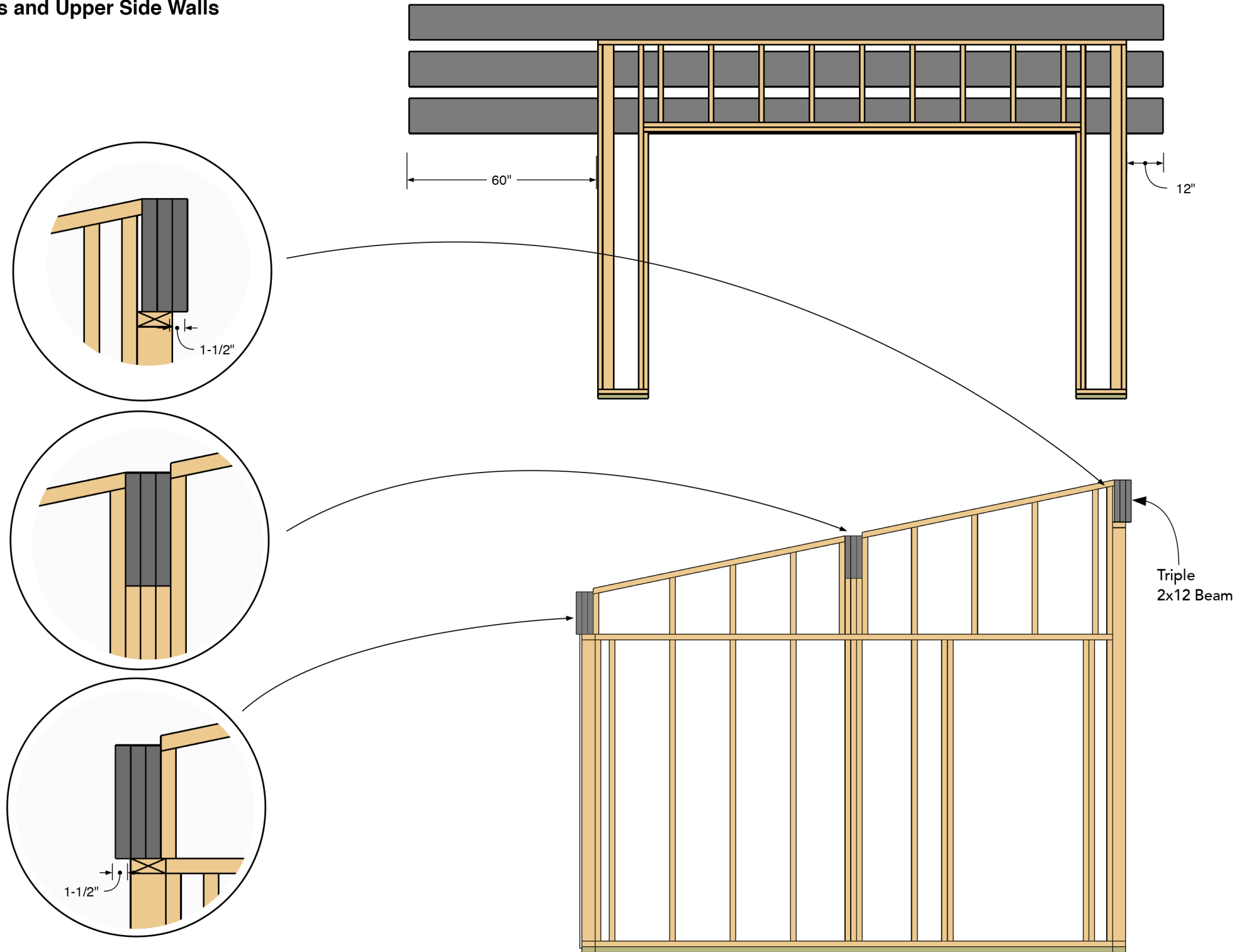

**Figure G**  
**Roof Framing**

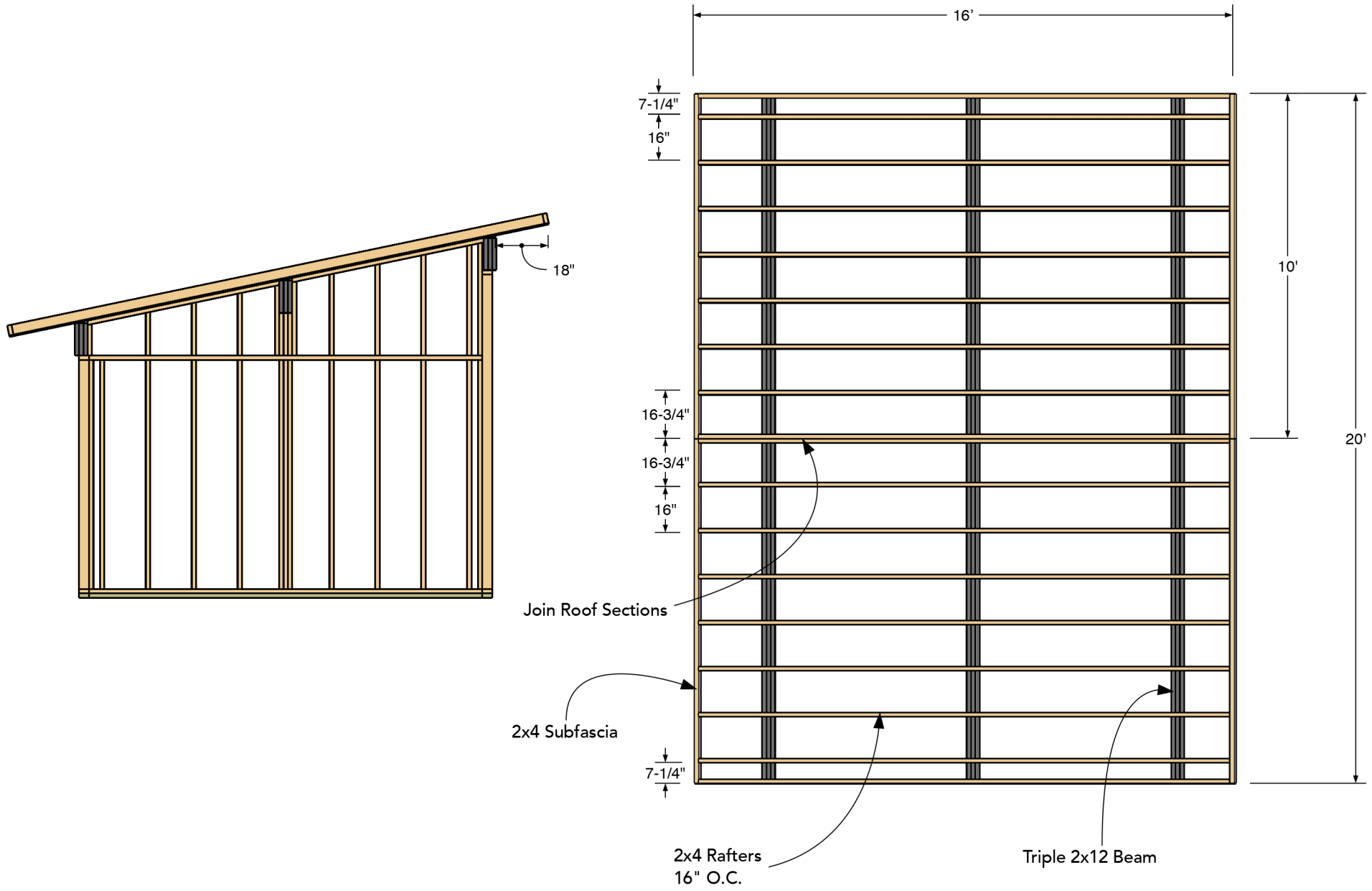

**Figure H**  
**Ceiling and Roof Panels**

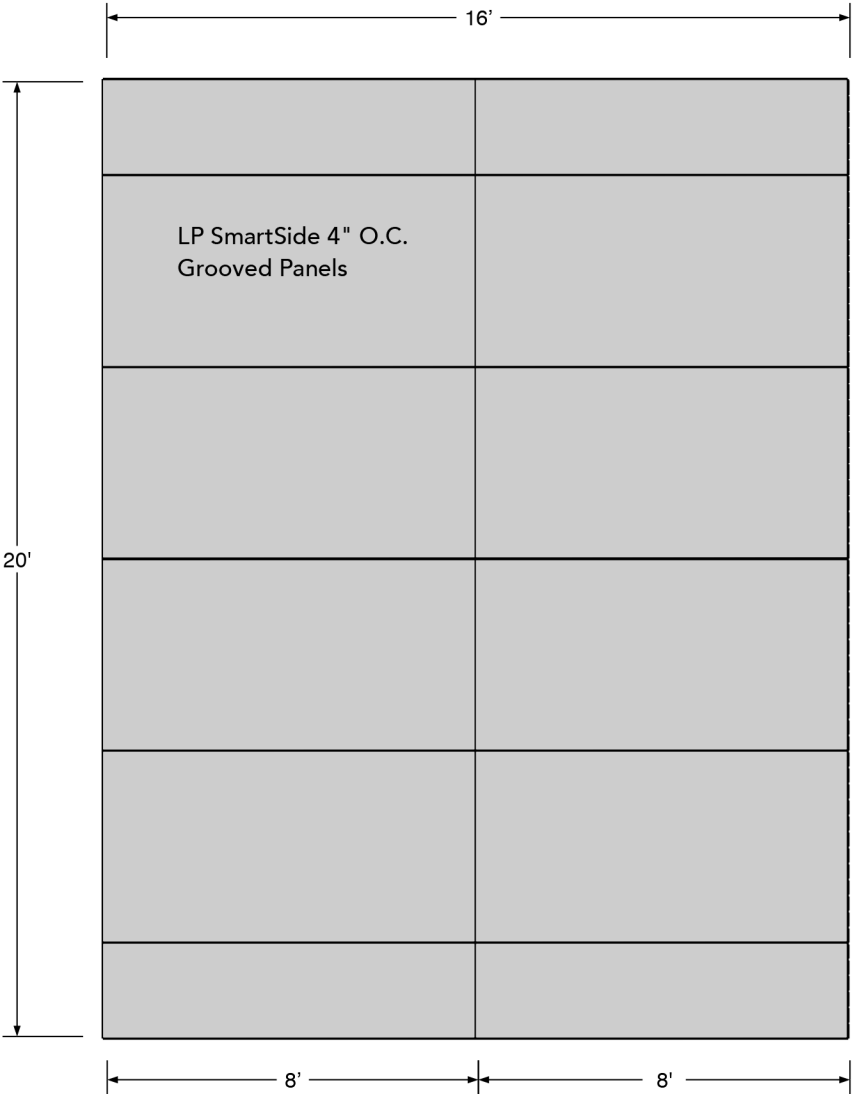

**CEILING PANEL LAYOUT**

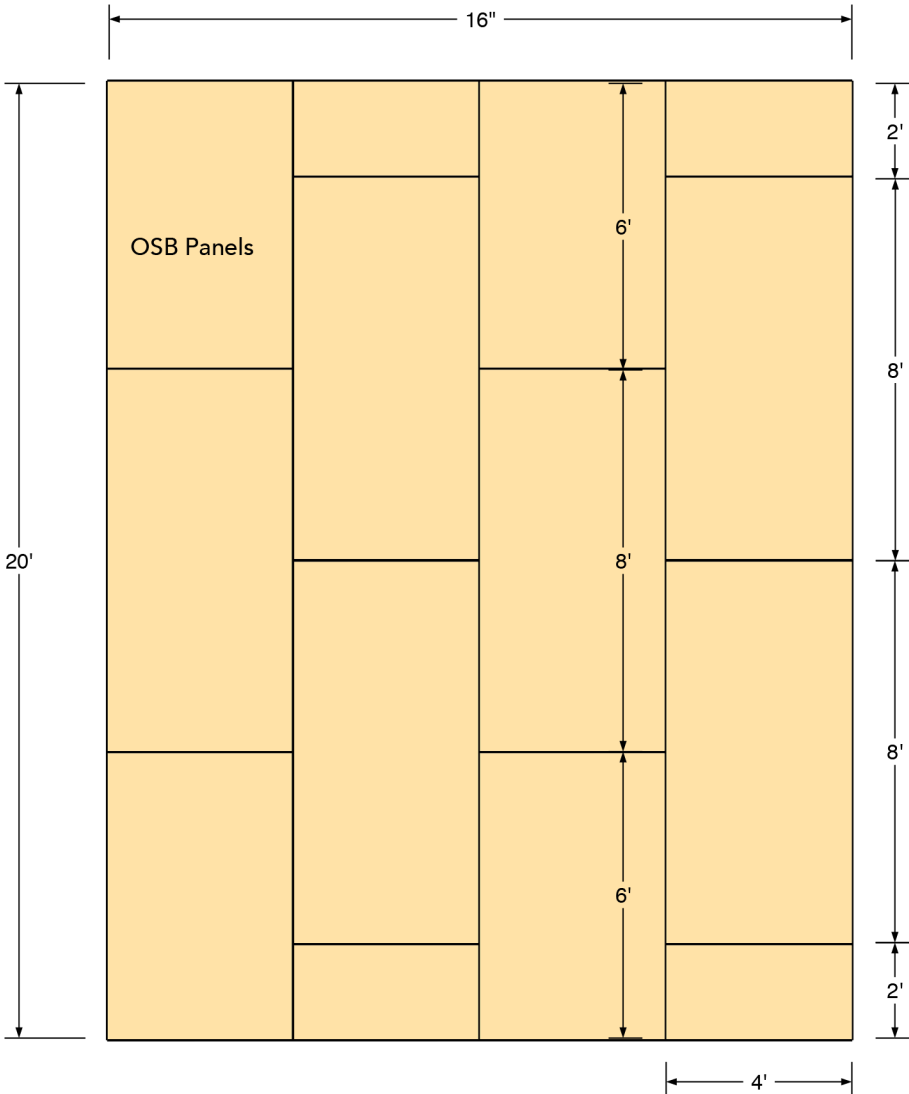

**ROOF SHEATHING LAYOUT**

**Figure J**  
**Siding Placement**

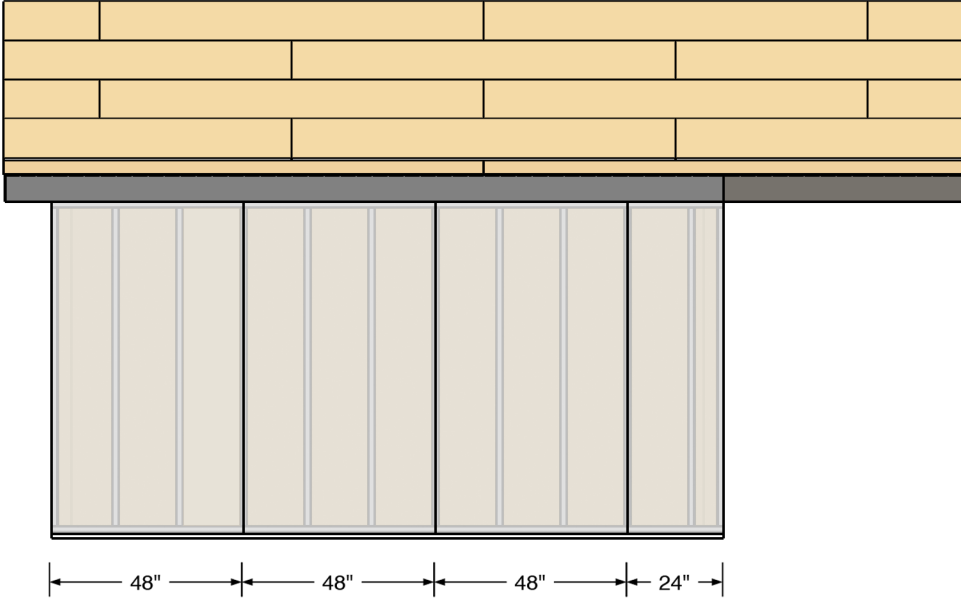

**BACK (without storage)**

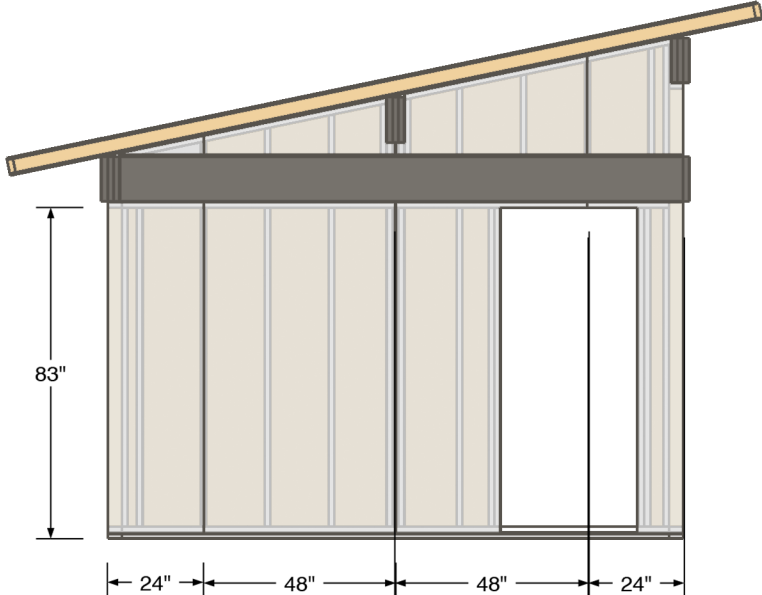

**LEFT SIDE**

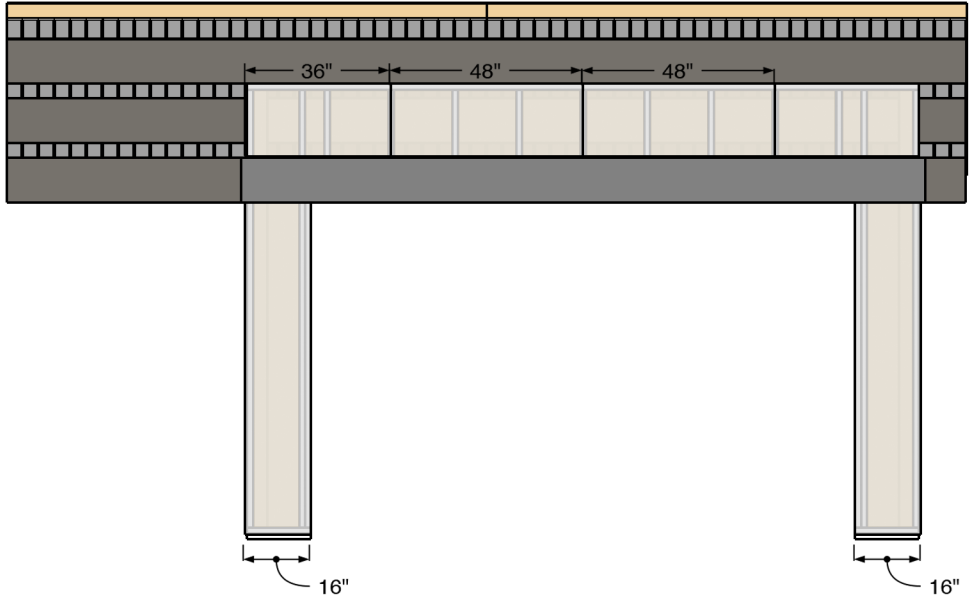

**FRONT**

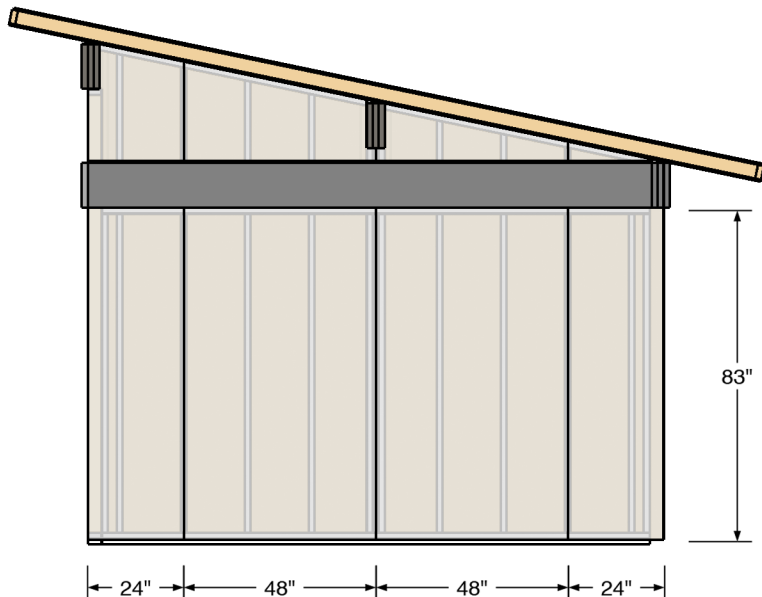

**RIGHT SIDE**



**Figure K**  
**Trim Placement**

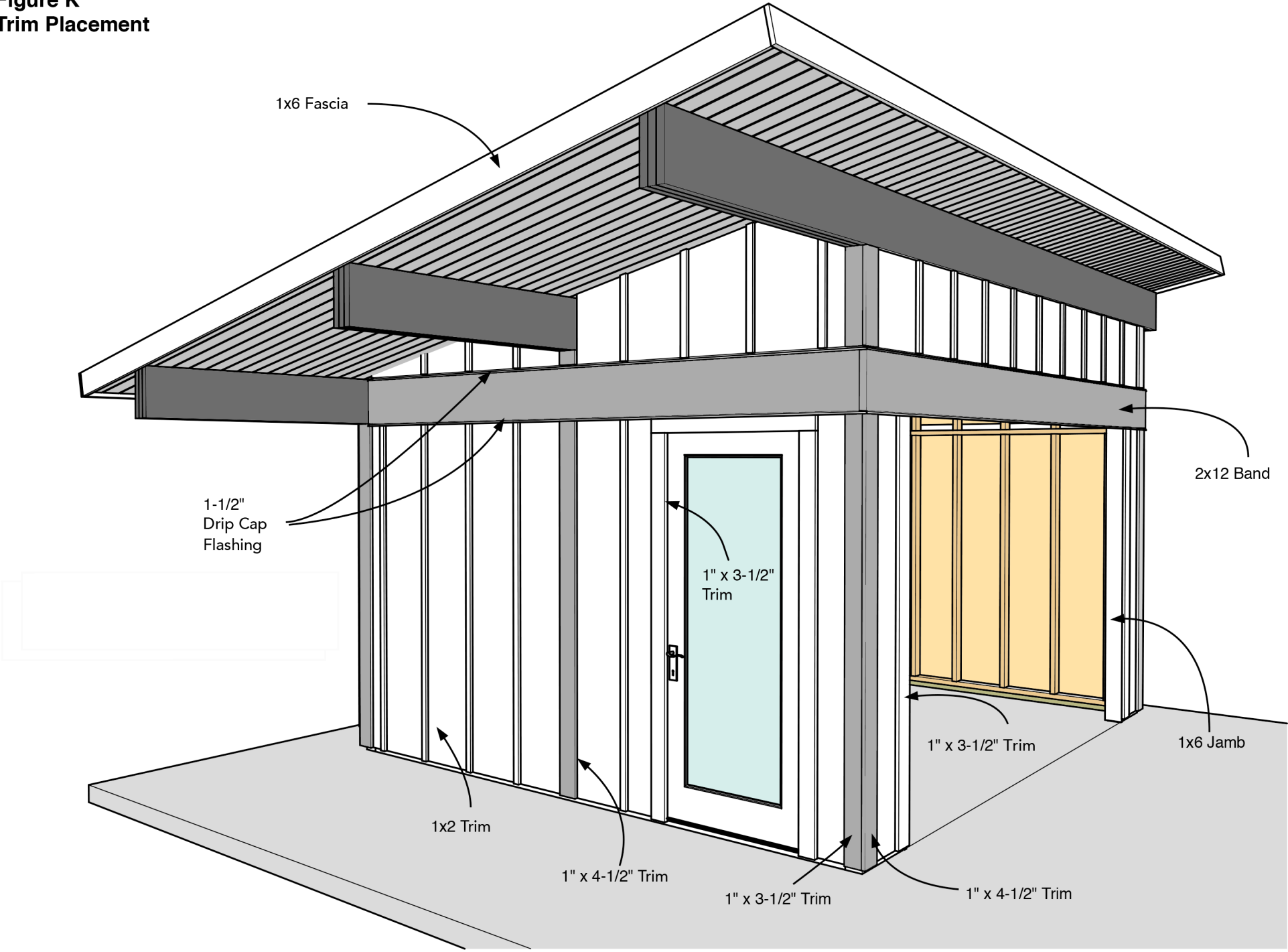

**Figure L  
Flashing Details**

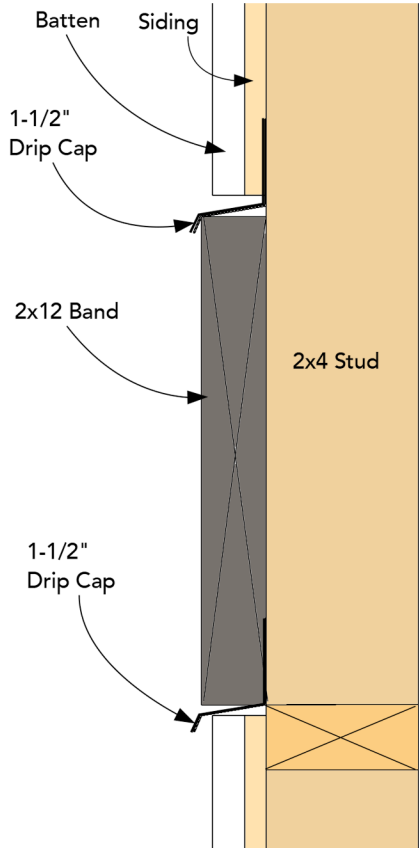

**2x12 BAND FLASHING**

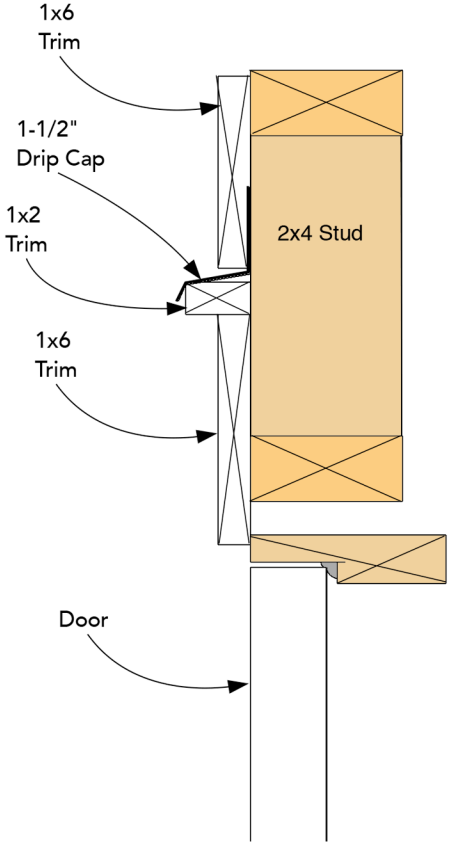

**STORAGE DOOR FLASHING**

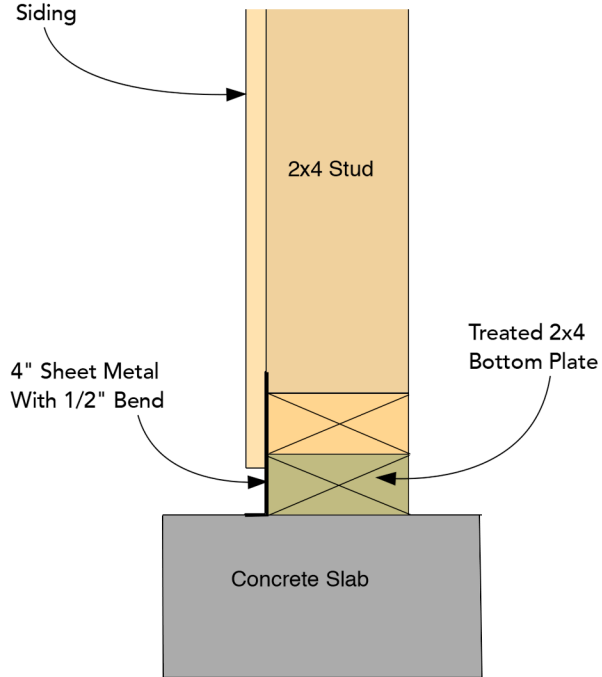

**WALL BOTTOM FLASHING**

**Figure M**  
**Storage Framing, Siding and Trim**

**STORAGE FRAMING**

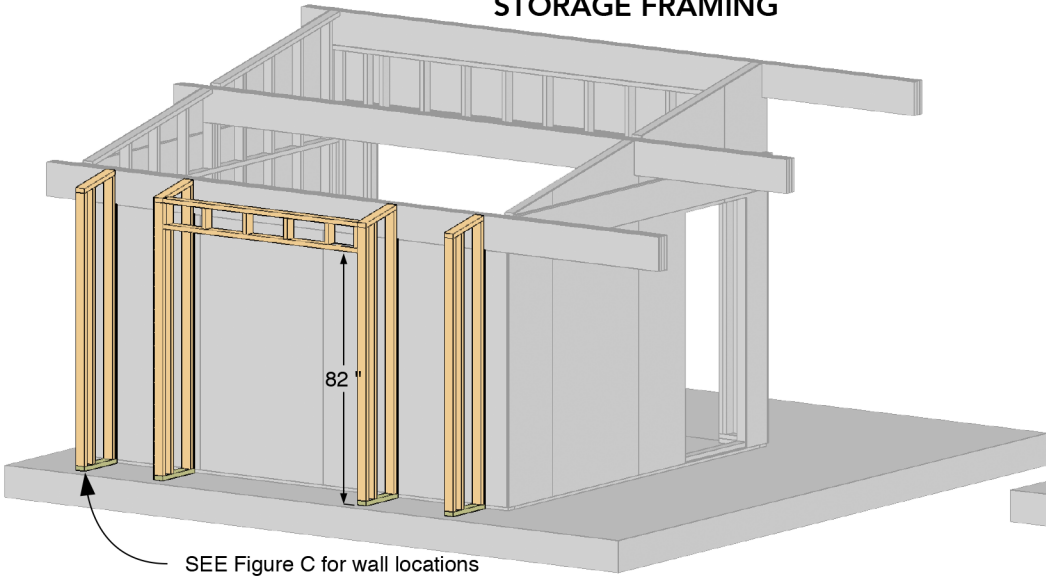

**STORAGE SIDING**

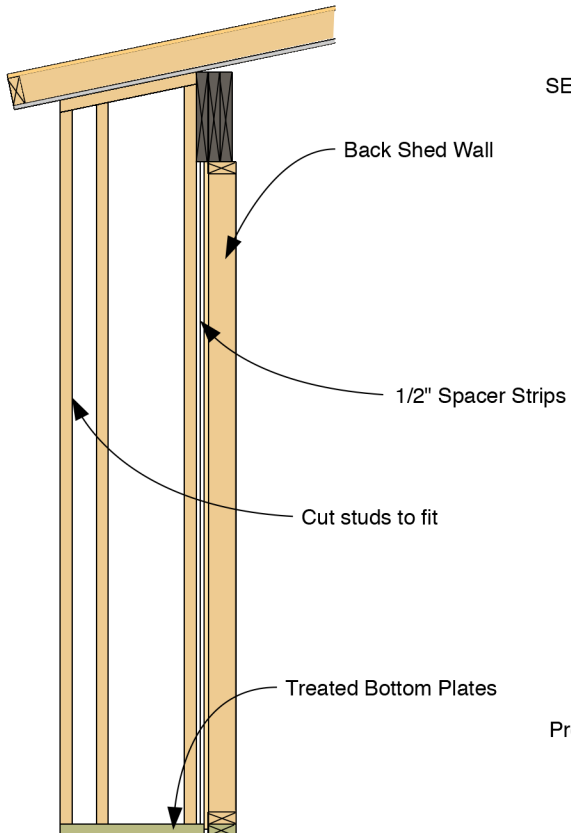
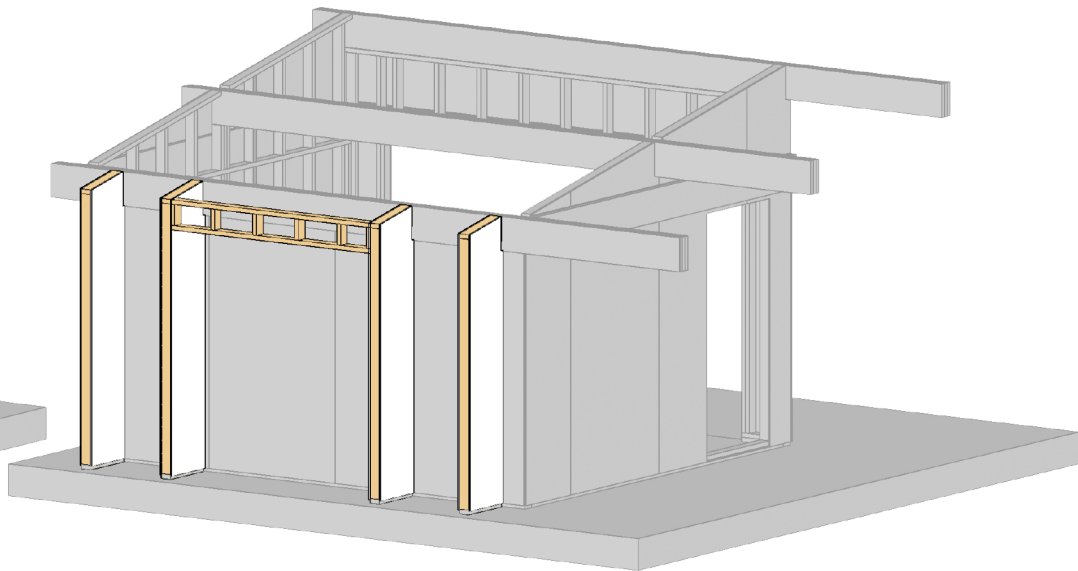

**STORAGE DOOR AND TRIM**

